

Blueair Sense+

User Manual

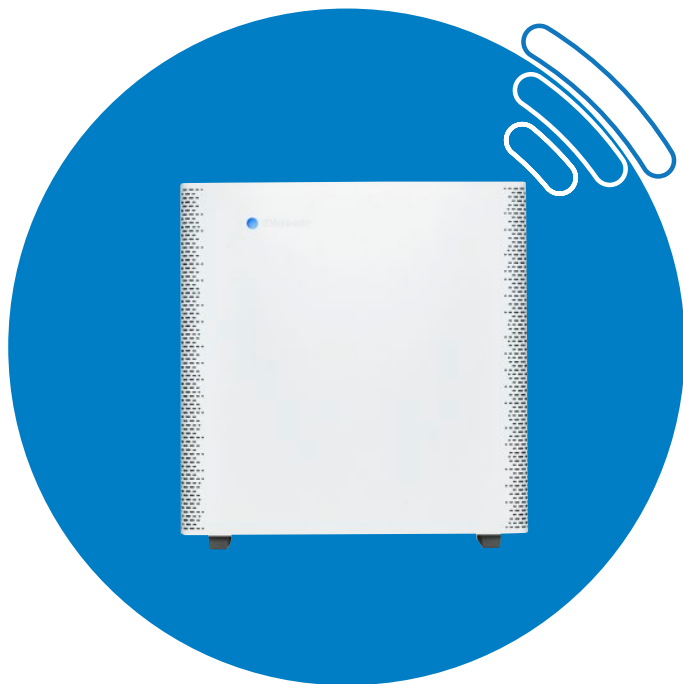

The intelligent, Wi-Fi enabled Blueair Sense+™ cleans your indoor air completely five times in an hour, turning any room up to 18 square meters (186 square feet) into a healthy air zone. You can control it wirelessly with a smartphone – or automatically with the Blueair Aware™ air monitor that also gives air quality readings.

Before using Blueair Sense+, please read this user manual carefully.

Contents

General safety information	5
Get the most out of it	7
Place it	7
Start it	7
Connect it wirelessly to your smartphone.....	7
Control it	9
Care for it	10
Change filter	11
Blueair filter subscription program	13
Help and support	13
Warranty information	13
Technical specifications	14

Welcome to your new air purifier

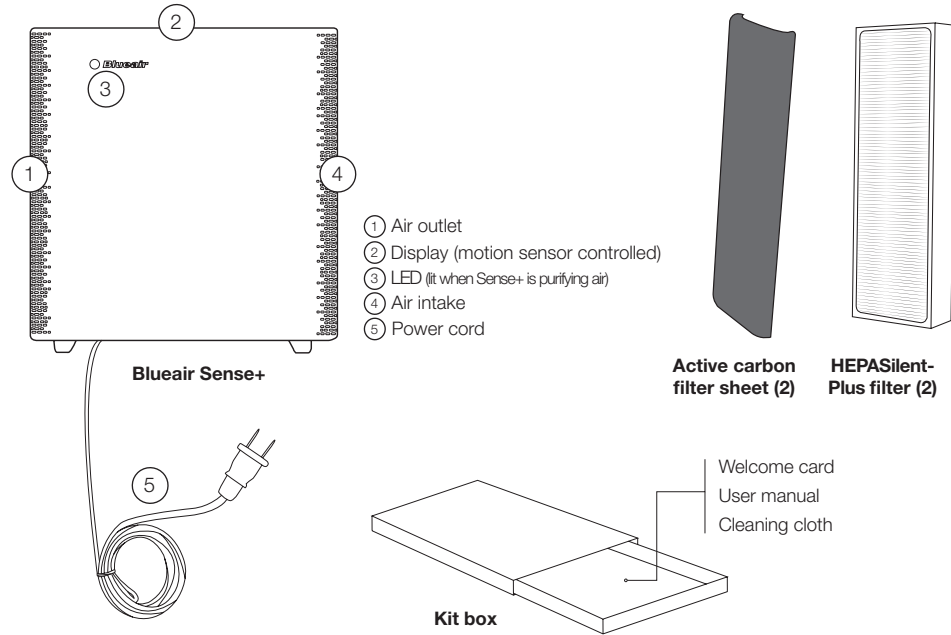

Sense+ comes with Blueair's patented HEPASilentPlus™ – the world's most advanced and silent filter system. It's a revolutionary combination of mechanical and electrostatic filtration. Air is drawn into the air purifier where large airborne particles and gaseous pollutants are captured in the first filter cassette. The air continues through an ion chamber where particles not captured mechanically are charged with negative ions, so they get attracted and caught by oppositely charged fibers in the second filter cassette. The purified air, virtually contaminant-free, is then re-circulated into the room.

General safety information

The Blueair Sense+ air purifier is an electrical appliance. Please take the necessary precautions to reduce the risk of fire, electric shock or injury.

- ⚠️ ○ The plug fits into a grounded outlet – do not alter the plug in any way.
- Plug Sense+ directly into an appropriate electrical outlet – please refer to the voltage label on your unit.
- This unit can be used by children aged from 8 years and above and persons with reduced physical, sensory or mental capabilities or lack of experience and knowledge, if they have been given supervision or instruction concerning use of the unit in a safe way and understand the hazards involved.
- Children must not play with the appliance.
- Cleaning and maintenance must not be done by children without supervision
- Please do not use the device with any non-Blueair accessories

Warning: Changes or modifications to this unit not expressly approved by the party responsible for compliance could void the user's authority to operate the equipment.

NOTE: This equipment has been tested and found to comply with the limits for a Class B digital device, pursuant to Part 15 of the FCC Rules. These limits are designed to provide reasonable protection against harmful interference in a residential installation. This equipment generates, uses and can radiate radio frequency energy and, if not installed and used in accordance with the instructions, may cause harmful interference to radio communications.

However, there is no guarantee that interference will not occur in a particular installation. If this equipment does cause harmful interference to radio or television reception, which can be determined by turning the equipment off and on, the user is encouraged to try to correct the interference by one or more of the following measures:

- Reorient or relocate the receiving antenna.
- Increase the separation between the equipment and receiver.
- Connect the equipment into an outlet on a circuit different from that to which the receiver is connected.
- Consult the dealer or an experienced radio/TV technician for help.

This device complies with Part 15 of the FCC Rules. Operation is subject to the following two conditions:

- (1) this device may not cause harmful interference, and
- (2) this device must accept any interference received, including interference that may cause undesired operation.

This device complies with Industry Canada licence-exempt RSS standard(s). Operation is subject to the following two conditions: (1) this device may not cause interference, and (2) this device must accept any interference, including interference that may cause undesired operation of the device.

This Class B digital apparatus complies with Canadian ICES-003.

FCC RF Radiation Exposure Statement Caution: This Transmitter must be installed to provide a separation distance of at least 20 cm from all persons.

  FCC ID: 2AEX3-Sense+
IC ID: 20267-Sense+

Get the most out of it

Maximum speed is recommended for fast initial cleaning or for heavily polluted air. After a few minutes, the speed can be reduced. Minimum speed is generally recommended for nighttime use.

For best results, run Sense+ 24/7. This ensures that clean, filtered air constantly circulates throughout the room. Sense+ uses as little as 7 W, less than a low-energy light bulb.

Place it

Sense+ should be placed in a location that allows air to circulate freely in, out and around the unit. Minimum distance from another object is 10 cm.

- ⊘ Don't place the unit:
 - Directly on or against soft furnishings, such as bedding or curtains.
 - Near sources of heat, such as radiators, fireplaces or ovens.
 - Near wet areas, such as bathrooms or laundry rooms, where it may come into contact with water.
 - Outdoors.

Start it

Plug Sense+ into a grounded electrical outlet with the supplied power cord. To turn it on for the first time, sweep your hand over the top display. A blue LED on the front side indicates that the unit is working.

Connect it wirelessly to your smartphone

1. Download the Blueair Friend™ app to your smartphone (available for iPhone and Android).
2. Activate Sense+ by sweeping your hand over the top display – when a Wi-Fi symbol and a circle are pulsing, Sense+ is ready to be connected to the Blueair app.

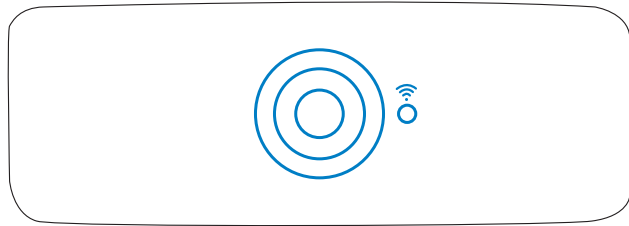





3. Make sure you are connected to the Wi-Fi network you want Sense+ to be connected to. Start the app and follow setup instructions. For more information, tap on ⓘ (Support) ► “FAQ” or “Troubleshooting”.
4. Now Sense+ is connected to your smartphone and can be controlled wirelessly.

Control it

Thanks to built-in Wi-Fi you can adjust the settings on Sense+ both wirelessly and manually.

Wirelessly with the Blueair app:

-  *Adjust airflow speed*
Tap in circle to change speed. Off = all circles are gray.
-  *Adjust LED intensity*
Tap in circle to change intensity. Off = all bars are gray.
-  *Child lock*
Tap in circle to switch child lock on/off. When on, you can adjust airflow speed only with the app, not on the unit.
-  *Auto mode*
Enabled only if you have both the Blueair Aware and the Sense+ connected to the app. In Auto mode the Blueair Aware controls the Sense+ automatically, based on real-time indoor air quality analyses.
 - Tap in circle to switch Auto mode on/off.
 - Tap to choose which Blueair Aware device you want to control the Sense+
-  *Night mode*
Change airflow speed and LED intensity during selected hours and weekdays.
 - Tap in circle to switch Night mode on/off.
 - Tap in circle to change airflow speed. Off = all circles are gray. This speed will only apply during the times and on the days that Night mode is set for.
 - Tap in circle to switch LED on/off. This setting will only apply during the times and on the days that Night mode is set for.
 - Drag/tap in outer circle to set start and end time.
 - Tap to select days.(Default Night mode settings are airflow speed 1 and LED off during all days between 9 PM and 7 AM.)

Manually with motion sensor control:

Change airflow speed by simply swiping your hand over the Sense+ top display. One swipe takes you to the next speed setting.



Unit off or display on standby for energy saving.

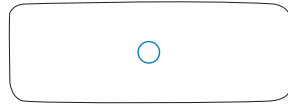

Speed setting 1.

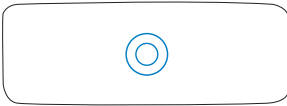

Speed setting 2.



Speed setting 3 — next swipe will turn the unit off.

Care for it

To keep Sense+ in top condition, we recommend routine cleaning. Always disconnect the unit from the electrical supply before cleaning or maintenance.

- Vacuum the small inlets with a soft brush.
- Vacuum the air intake grille from the inside (e.g. when you change filter).
- Wipe the exterior with the supplied cleaning cloth.

⊘ What you can't do:

- Never clean Sense+ with gasoline, chemical solvents or corrosive material – these agents may damage the surface.
- Never allow foreign objects to enter the ventilation or exhaust openings – this may cause electric shock or damage the unit.
- Never try to repair or adjust any of the electrical or mechanical functions yourself. Contact your local Blueair retailer.

Change filter

Sense+ comes with Blueair's patented HEPASilentPlus, the world's most advanced and silent filter system. The unit uses two filter cassettes. Each cassette consists of two parts:

Advanced particle filter – removes dust, pollen, pet dander, mold spores, bacteria, viruses and other airborne pollutants down to the tiniest particle.

Active carbon filter sheet – removes gaseous pollutants such as cigarette and cigar smoke or other VOCs (volatile organic compounds, including household paint and other chemicals).

To ensure the unit's high quality performance we recommend that you only use original Blueair filters, replacing them every 6 months.



When change is required, a red indicator light will show on the top display.

Filter change step-by-step:

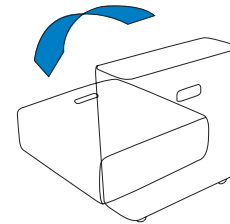

1. Turn off the unit, pull out the power plug, and put the unit down with the backside facing up (on a soft surface like a blanket).

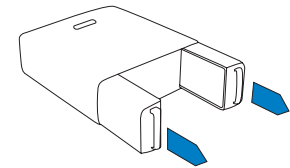

2. Pull out the two filter cassettes using the handles. You may need to pull firmly.

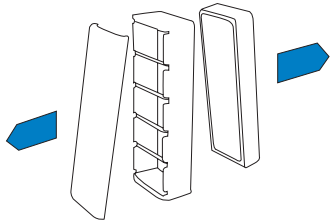

3. Take out the particle filters and carbon filter sheets from each cassette.

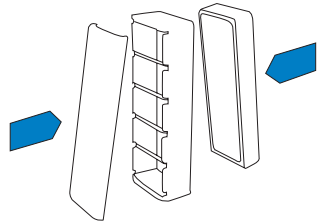

4. Push in the new filters in each cassette.

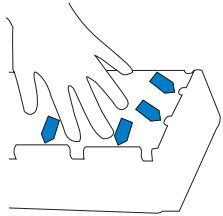

5. Make sure the carbon filter sheets stay in place by pressing down the filters below the tabs on the cassettes.

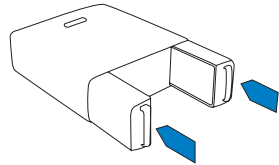

6. Slide the filter cassettes back into place.

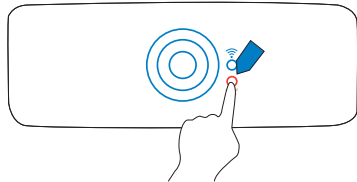

7. Plug in the power cord, put the unit in upright position, and press on the red filter replacement indicator for 30 seconds. Your Sense+ is ready once again to ensure you are breathing cleaner, healthier air.

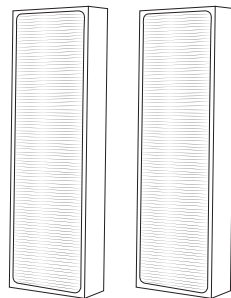

Detailed instructions for filter changing also come with your new filter.

Filter checklist

To make it easy to find the right filter in the future, please fill in the customer record below and keep this user manual for reference. The model number and serial number of this product can be found on the bottom of the unit.

Model number _____ **Retailer's name** _____

Serial number _____ **Retailer's address** _____

Date of purchase _____ **Telephone number** _____

Blueair filter subscription program

This convenient service is available in some countries – contact your local Blueair retailer to find out if you can join.



Help and support

For more information, start the Blueair app and tap on ⓘ (Support) ▶ “FAQ” or “Troubleshooting”. If you can't solve the issues, please visit www.blueair.com or contact your local Blueair retailer.

Warranty information

Blueair warrants the included hardware product and accessories against defects in materials and workmanship. Warranty benefits may vary locally. Full terms and detailed information about what applies in your country is available at www.blueair.com. To extend your limited warranty, register in the Blueair app (tap on “Profile”) or on our website.

Technical specifications*

CADR**	 120  140  150
Room size	186 ft ² (18 m ²)
Air changes per hour (ACH)***	5
Airflow (Speed 1-2-3)	35-84-150 cfm (60-155-255 m ³ /h)
Size (HxWxD)	19.5x18.5x6.7 in (492x470x170 mm)
Product weight:	24 lbs (11 kg)
Energy consumption (Speed 1-2-3)****	7-20-45 W
Sound pressure level	29-40-50 dB(A)
Filter replacement indicator	Yes
Speed control options	1-2-3, non-touch, smartphone
	The entire unit can be recycled.

External network issues affecting the product performance are beyond the control of Blueair. Please contact your Internet service provider for assistance.

* Specifications based on U.S. models (120 VAC, 60 Hz with particle filter).

** The CADR indicates how much filtered air is delivered (airflow) by the air purifier operating at the highest setting, and how well the system removes tobacco smoke, dust and pollen pollutants from the air (efficiency).

*** Tests are performed in accordance with ANSI/AHAM AC-1. The maximum possible CADR ratings according to this standard are: Tobacco Smoke: 450 cfm. / Dust: 400 cfm. / Pollen: 450 cfm.

Air changes per hour are calculated on the recommended room size, assuming 8-foot (2.4 m) ceilings. For smaller rooms, the air changes per hour will increase.

**** The available electrical power voltage and frequency affects the power consumption of the unit. The power consumption might therefore be different from the stated value.



www.blueair.com

Blueair AB

Danderydsgatan 11
SE-114 26 Stockholm
Sweden

Tel: +46 8 679 45 00
Fax: +46 8 679 45 45
info@blueair.se

Blueair Inc.

Suite 1900,
100 N LaSalle Street
Chicago, IL 60602
Tel: +1 888 258 3247
Fax: +1 312 727 1153
info@blueair.com

Blueair India Pvt. Ltd.

Embassy of Sweden
Nyaya Marg, Chanakyapuri
New Dehli – 110021
Tel: +91 11 4606 7121
Fax: +91 11 4606 7120
india@blueair.se

Blueair (Shanghai) Trading Co. Ltd.

Rm 1005 City Gateway
No. 398 North Caoxi Road
Xuhui Distr, Shanghai
Tel: +86 21 6091 0981
Fax: +86 21 6091 0989
info@blueair.cn